

CORNER  
WC-7-C

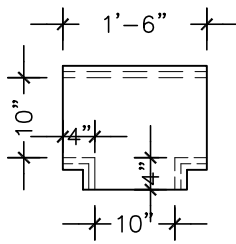

TEE  
WC-7-TEE

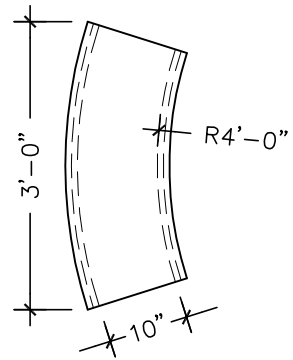

4' RAIUS  
WC-7-4'RAD

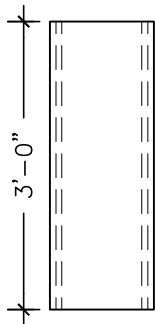

TOP

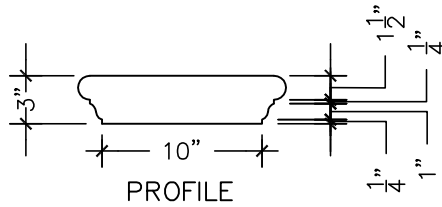

PROFILE

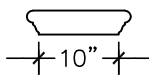

PROFILE  
WC-7-S

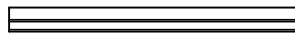

SIDE

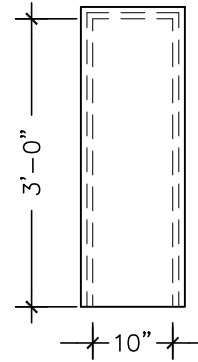

TERMINAL  
END  
WC-7-TL

WC-7



**ARCHITECTURAL  
PRECAST  
DESIGNS, LLC**

*2818 east illini street  
phoenix, arizona 85040  
602.323.2515 (o)  
602.323.2558 (f)*

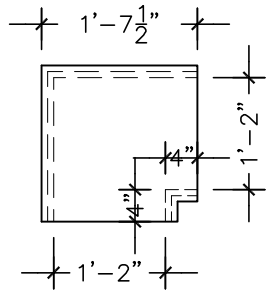

CORNER  
WC-8-C

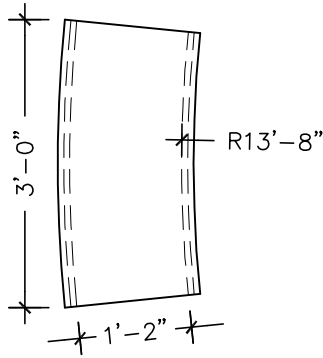

13'-8" RADIUS  
WC-8-13'8"RAD

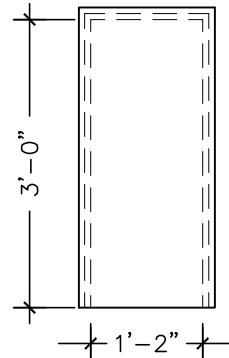

TERMINAL  
END  
WC-8-TL

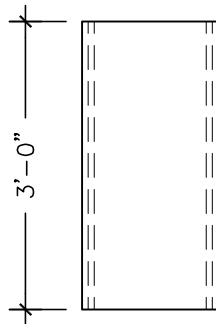

TOP

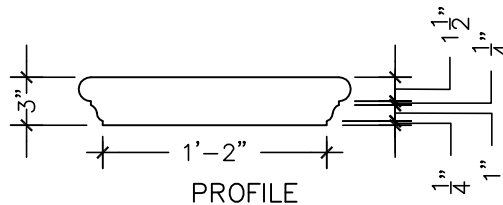

PROFILE

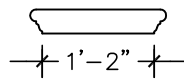

PROFILE  
WC-8-S

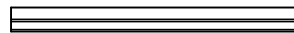

SIDE

WC-8



**ARCHITECTURAL  
PRECAST  
DESIGNS, LLC**

*2818 east illini street  
phoenix, arizona 85040  
602.323.2515 (o)  
602.323.2558 (f)*